



200 Range Dialer Installation Manual

Version 1.0

Now certified
and compliant with
EN50131, EN50136
Security Grade 4
ATSG

The information contained is supplied without liability for any errors or omissions. No part may be reproduced or used except as authorised by contract or other written permission. The copyright and foregoing restriction on reproduction and use extend to all media in which the information may be embedded.

© 2008 *Chiron Technology Ltd*

Contents

1.	Introduction	1
1.1.	About this manual...	1
1.2.	Overview	1
1.3.	System specifications	2
2.	Before you start...	3
2.1.	Package contents	3
2.2.	Pre-requisites	3
3.	Alarm dialer interface	4
4.	Installing the IRIS Touch Dialer	4
5.	Configuring the IRIS Touch Dialer	7
6.	Post installation	8
7.	PIN alarms	8
7.1.	Installation	9
7.2.	Default alarm messages	10
8.	Relay outputs	10
9.	Troubleshooting	10
	Appendix A – Settings menu	11
	Appendix B – Installation photos	12
	Appendix C – Specification	14

1. Introduction

1.1. About this manual...

This manual is designed to help you, the Installer, with the installation process for the IRIS Touch alarm dialer. We recommend that you read through this manual, in its entirety, before you visit the customer's site and begin the installation.

1.2. Overview

The IRIS range of alarm dialers allow users to migrate intruder alarm systems away from traditional PSTN communications to IP based and/or wireless networks, without the need to upgrade or replace the alarm system.

The majority of intruder alarm systems which are configured to make alarm calls to a central monitoring station use the traditional PSTN analogue network as the communications path. However, PSTN is becoming increasingly unsuitable as users move to IP and Voice over IP (VoIP) for their fixed networks or rely purely on mobile (GSM and GPRS) communications. In addition most PSTN service providers are migrating to VoIP networks, so in the not too distant future PSTN lines may be withdrawn.

The IRIS dialer range is unique in offering a quick and cost effective way to interface any existing alarm system to alternative networks such as GSM, Ethernet and GPRS. As a result of the flexibility and power of IRIS it has become the IP transmission system of choice for Monitoring Centres across Europe.

The IRIS 200 series is intended to be used with alarm panels that do not have sufficient space inside their enclosures for an IRIS dialer. There are three dialers in the range:

- IRIS Touch 200 - GSM
- IRIS Touch 220 - Ethernet
- IRIS Touch 240 - Ethernet & GPRS

The IRIS Touch dialer should be located next to the alarm panel and powered from the panel's internal battery backed DC supply.

1.3. System specifications

Feature	Touch 200 GSM	Touch 220 Ethernet	Touch 240 Ethernet & GPRS
Stylish, tamper proof enclosure	✓	✓	✓
Easy to install and test with touch screen interface	✓	✓	✓
2-wire (POTS) analogue interface to standard alarm dialers	✓	✓	✓
Support for SIA (1-3), Contact ID, Scancom (Fast Format) and Robofon protocols	✓	✓	✓
Pin inputs for alarm messages over SMS	4	4	4
Relay contact outputs	2	2	2
9-30V DC power from alarm panel	✓	✓	✓
USB port for local configuration	✓	✓	✓
Secure polling (monitoring) over Ethernet		✓	✓
Secure alarm transmission over Ethernet		✓	✓
Pin inputs for alarm messages over Ethernet or GPRS		4	4
Configuration and diagnostics over Ethernet		✓	✓
Secure polling (monitoring) over GPRS			✓
Secure alarm transmission over GPRS			✓
Configuration and diagnostics over GPRS			✓
Alarm transmission over GSM	✓		✓

2. Before you start...

2.1. Package contents

In this package you should have the following components:

- Main dialer unit comprising:
 - PCB with 3 part plastic enclosure (back, front and slider).
 - 4 x assembly screws.
 - 2 x tamper switch springs.
- Power cable (black) for connection to DC supply.
- Ethernet cable (cream) for connection to IP network. (*Ethernet / Ethernet & GPRS only*).
- Antenna for GSM/GPRS. (*GSM / Ethernet & GPRS only*).
- Dialer cable (grey) for connection to dialer output of alarm panel.
- Screws and plugs (3 of each) for wall mounting.
- Sense resistor (18K ohm) for alarm dialer cable fault/tamper detection.
- Installation manual.

2.2. Pre-requisites

For installations using IP (Ethernet) or GPRS you **must** ensure you have the following:

- The IP address for the Monitoring Centre.
- Confirmation that the Monitoring Centre is set up and ready for the account number or name to be used for this IRIS dialer.
- The type of IP address (either automatic or fixed) for the installation site. If the site has a fixed IP address, you should get this information from the customer in advance, together with the Gateway Address and the Subnet Mask for the IRIS dialer.
- An additional long Ethernet cable, in case the installation site requires one longer than that supplied with the IRIS dialer.
- A SIM card enabled for GPRS with the PIN code clear. (*Ethernet & GPRS only*.)
- The GPRS Access Point Name (APN) of the SIM card provider. Some networks also require a User Name and Password which can also be obtained from the SIM card provider. (*Ethernet & GPRS only*.)

3. Alarm dialer interface

IRIS dialers carry alarm signals from the alarm panel over IP completely transparently so when they arrive at the Monitoring Centre it is as though they had come over a traditional PSTN connection. IRIS dialers support SIA (Levels 1 to 3), Contact ID, Scancor (Fast Format) and Robofon protocols, one of which virtually all alarm panels will support.

Apart from the following, no reconfiguration of the alarm panel is required for use with IRIS dialers:

1. If alarm signalling over Ethernet or GPRS is required, change the setting in the alarm panel for the telephone number to be dialled for alarm signalling. This number should be changed to the IP address of the Monitoring Centre, entered as 12 digits. Each of the four IP address numbers separated by a '.' should be entered as a 3 digit number, with leading '0's as required, and the '.'s should be excluded. For example:

IP address **10.1.146.22** is entered as **010001146022**.

If the Monitoring Centre requires a backup IP address to be entered, this is done in the same way.

2. If alarm signalling over GSM is required, add a leading digit '7' to the normal PSTN telephone number of the Monitoring Centre.
3. If the panel is required to make outgoing calls over IP for upload/download or remote configuration, then where the telephone number for this would normally be entered, put in the digit '8' followed by the destination IP address in 12 digit format, as above.

4. Installing the IRIS Touch Dialer

Use the following procedure to install the IRIS Touch Dialer.

Note: For installations using PIN alarm inputs see the *PIN alarms* section for additional information and for wiring to relay outputs see the *Relay outputs* section.

-  Do not apply power to the dialer until indicated.

1. Decide where to run the cables

Decide the best way to run the cables to the PCB. This can be either:

- Behind the unit (through the wall).
- Through the bottom of the back plate of the unit (via the 'knock outs').

2. Disassemble the unit

Remove the two case fixing screws [1] and open the unit [2]. Remove the two PCB fixing screws [3] and remove the PCB.

3. Mount the unit on the wall

Position the back plate on the wall, drill 3 holes, put the cables through the opening at the base of the plate [4], or via the 'knockouts' [5], and secure the plate to the wall with the 3 screws supplied [6].

4. Plug in the connectors

Connect the relevant cables to the PCB:

- Ethernet cable (cream) [7] (Ethernet / Ethernet & GPRS only)
- Dialer cable (grey) [8]
- Power cable (black) [9]

5. Install the antenna (*GSM / Ethernet only*)

Position the antenna in the groove in the back plate of the unit [10] and connect the antenna to the PCB [11].

Note: Alternatively you can use an external antenna if the location of the internal antenna does not give sufficient signal.

6. Fit the tamper switch springs

The IRIS dialer is protected against tampering (e.g. removal from the wall or opening of the case) by two tamper switches [12] – one either side of the PCB. These switches are held by springs that press against the wall and the top cover.

Before fitting the PCB, make sure the springs that come with the unit are fitted correctly to the tamper switches.

7. Fit the PCB to the back plate

Fit the PCB to the back plate, aligning the corners of the plate with the edgings on the back plate and the two bottom screw fittings [13]. Screw in the 2 top screws only [14].

8. Fit the SIM card (*GSM / Ethernet & GPRS only*)

Fit the SIM card [15].

 Power must not be applied to the PCB while the SIM card is being fitted or removed or it may be damaged.

9. Plug in the external cables

- Plug the dialer cable into the alarm panel dialer. If the alarm panel has screw connections, cut the connector off the cable and strip the cable using the 2 inner wires. Polarity is not important.
- Plug the Ethernet cable into the local IP router or socket that has been allocated for the IP connection.

10. Plug in the sense resistors

Fit the 18K sense resistor in parallel with the dialer output of the alarm panel, at the alarm panel end of the cable.

Note: This resistor enables the IRIS dialer to detect cable faults and/or tampers and *must* be fitted at the alarm panel end of the cable to function correctly.

11. Fit the front cover

Slot the top of the front cover into the top of the back plate and click the bottom of the front cover to the bottom of the back plate.

Fix in place with the 2 screws provided [16].

Pull down the slider to reveal the touch screen.

5. Configuring the IRIS Touch Dialer

The majority of configurations can be carried out via the touch screen interface display on the IRIS dialer. For more complex systems, for example where the data port is used, additional configuration is available via the USB connector using a laptop / PC and IRIS dialer configuration software (available via the Chiron website).

The touch screen display on the IRIS dialer provides an Installation Wizard which guides you through a set of instructions for configuring the dialer. It is recommended that you use this Wizard as it automatically carries out tests as you proceed through the configuration.

Note: To select an option on the screen, touch the screen display.

Use the following procedure to configure the IRIS Touch Dialer:

1. Plug the power cable into the battery backed supply of the alarm panel. The cable with the white stripe is the –ve connection. Ensure that the display on the dialer becomes active.

The dialer carries out a self test and the Welcome screen then displays.

Note: If the power has been connected for the first time the Language menu displays. Select the appropriate language from the list of languages available.

2. Select the **Installer Menu** option from the Welcome screen.
3. Select the **Installation Wizard** option from the Installation Menu.
4. Follow the remaining instructions on the screen to complete the configuration.

Once the installation is completed successfully the message *Status - System OK* is displayed on the Welcome screen and the LED Indicator on the top of the unit [17] is on steady.

5. Carry out all the standard alarm signaling tests appropriate for the alarm system.
6. Push up the slider to cover the touch screen.

6. Post installation

Once you have completed the installation you must:

- Ensure the system is running correctly, the LED light on top of the unit is on steady and alarms are being signaled to the Monitoring Centre correctly.
- After a short period of inactivity the display will switch off. To switch it back on, touch the display anywhere.
- If a fault should develop, then the LED light on the top of the unit will start flashing and the display will show a system fault message. This message can be touched to gain access to more information. Ensure the user is aware of this and what action they need to take should a fault occur.

7. PIN alarms

The IRIS Touch series have PIN inputs [18] that can be used to generate alarm messages. These can be:

- Text messages via SMS (GSM / Ethernet & GPRS only).
- SIA alarm messages over IP to the Monitoring Centre (Ethernet / Ethernet & GPRS only).
- Fast Format alarm messages over IP to the Monitoring Centre (Ethernet / Ethernet & GPRS only).

The messages for each PIN can be configured via the Settings Menu on the touch screen display. See *Appendix A* for more details.

7.1. Installation

Each PIN input is designed to be connected in a loop via an open/close contact source from an alarm panel, or other device, to a reference ground PIN [19] available on the IRIS dialer, as shown below:

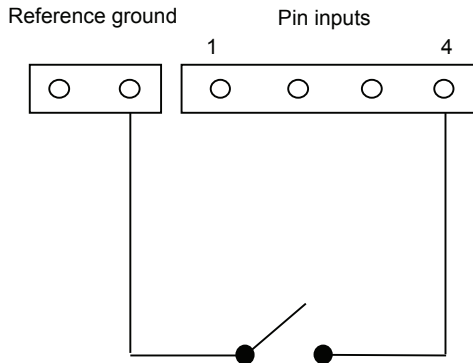

Opening the contact (i.e. loop is open circuit) generates an alarm signal. Closing the contact generates the equivalent restore signal.

It is also possible to link the contacts to the IRIS dialer via sense resistors so that an open or short circuit tamper on the loop can be detected and the Monitoring Centre alerted. In this case the connections should be made as shown below:

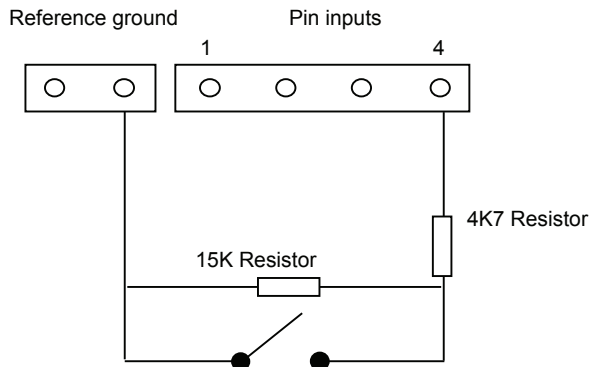

Note: For this feature to work correctly it is essential that the resistors are connected at the contact end of the loop and not the dialer end. The Monitoring Centre must also enable this facility on the dialer.

7.2. Default alarm messages

The default SIA messages for each PIN are shown below:

Pin	'Set' message	'Restore' message	Meaning
1	NBA01	NBR01	Burglary alarm/restore
2	NFA02	NFR02	Fire alarm/restore
3	NQA03	NQR03	Emergency alarm/restore
4	NOP04	NCL04	Open/close

8. Relay outputs

The IRIS dialer has two relay outputs [20] that can be used in a number of ways:

- To indicate communications path failure.
- Activation by incoming SMS Message.
- Setting by the Monitoring Centre.

The relay contacts are normally open and closed when activated.

Wire to these contacts as required and define how they are to be used using the configuration options on the Settings Menu. See *Appendix A* for more details.

9. Troubleshooting

Problem	Resolution
No screen display when IRIS dialer is connected to the power.	Check that there is power to the system and that the wiring is the correct polarity.
A fault develops and is indicated by the LED on the top of the unit flashing.	Touch the display and the instructions will guide you through identification of the problem. Go to the Installers menu and select Test to use the integrated test function.

Appendix A – Settings menu

Setting	Purpose
Network Interfaces	Selects which network interfaces are going to be used (i.e. Ethernet and/or Ethernet/GPRS). Stops dialer reporting trouble on interfaces not being used.
Account Number/Name	The IRIS account number/name, as allocated by the Monitoring Centre.
Monitoring Centre IP Address	IP address of the receiver at the Monitoring Centre.
Dialer IP Address	IP address of the dialer, i.e. either automatic (DHCP) or fixed.
GPRS Settings	GPRS Access Point Name (APN), user name and password. View signal strength.
Alarm Panel Interface	Selects whether or not the 2-wire cable to the dialer is monitored for short and open circuit. Note: For monitoring to function correctly a sense resistor must be fitted as described earlier in this manual.
Pin Inputs	Selects whether or not pin input is monitored (using sense resistors) and selects input function: <ul style="list-style-type: none"> • Send SMS message. • Send SIA format alarm over IP (trouble and restore event codes and zone number). • Send Fast Format alarm over IP (alarm or open/close) and set pin polarity.
Relay Outputs	Activation of relay outputs by incoming SMS messages.
Trouble Reporting	Selects how local communications problems are reported, via: <ul style="list-style-type: none"> • Relay outputs. • SMS. Sets the text string that appears on screen to advise the user what action to take (e.g. support centre telephone number). Sets IP address of support centre for remote diagnostics.
Language	Selects language.
Installer Password	Sets a password to the Installer menus, if required.
Contrast	Sets display contrast.
Tamper restore	Clears tamper alarm if tamper switches have been triggered.
Audio	The dialer has a diagnostic tool with integral speaker to allow the audio signal to and from the alarm dialer to be heard. The audio can be switched on and off.
Default all	Sets all settings back to factory defaults.

Appendix B – Installation photos

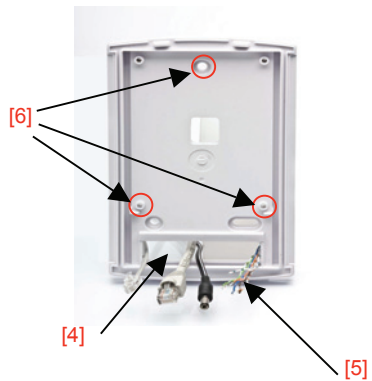
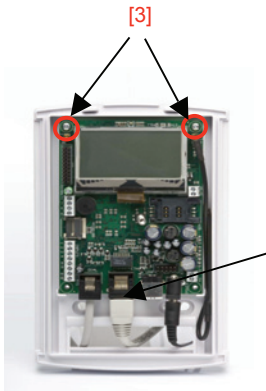

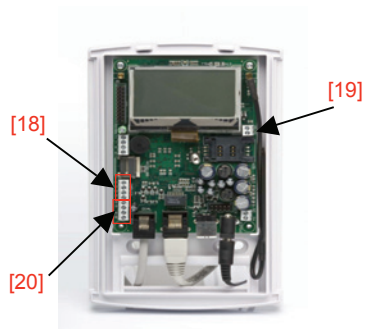
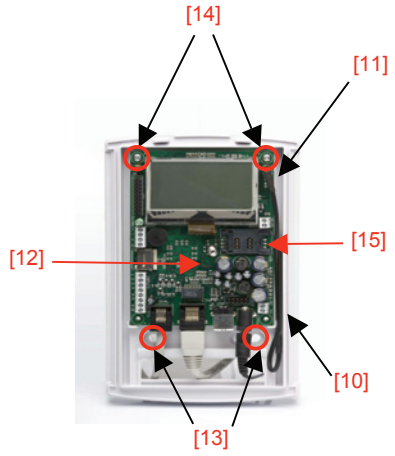
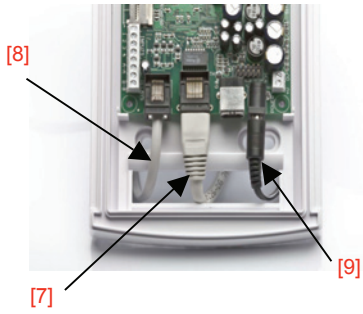

Appendix C – Specification

Alarm Dialer Interface	
Two wire interface via RJ11 socket	
40V feed at 12mA	
Ringing voltage 40V P-P to REN4 for incoming calls	
Off hook detection with dial-tone presented to alarm dialer	
DTMF tone recognition for dialing outgoing calls and alarm signaling	
Ethernet Interface	
10Mbps and 100Mbps (10/100BaseT) with auto-negotiation	
UTP with standard RJ45 socket for CAT-5 cabling	
Dynamic IP addressing (DHCP) or fixed	
GSM/GPRS Interface	
Dual band GSM 900 MHz and DCS 1800 MHz	
MMCX socket for antenna connection	
IP	
TCP ports (outbound): 51292 (diagnostics), 52737 (polling), 53165 (alarms)	
UDP ports for upload/download 8738 and 8739	
PIN Inputs	
Maximum input voltage range	0V to +24V
Input 'low' threshold	< 2V
Input 'high' threshold	> 3V
Input pull-up impedance	Internal 10K to 5V supply
Relay Outputs	
Maximum operating voltage	24V
Maximum current rating	1A
Power Supply	
Supply voltage	9 - 30V DC
Ethernet only (typical current) dialer on hook	145mA (supply at 12v)
Ethernet only (typical current) dialer off hook	175mA (supply ay 12V)
With GSM/GPRS (typical current) dialer on hook	185mA (supply at 12V)
With GSM/GPRS (typical current) dialer off hook	215mA (supply at 12V)
Note: These figures are based upon the Ethernet link being connected. With GSM/GPRS there will also be additional transient peak current of up to 250mA required as GSM and GPRS transmissions (e.g. for network registration and calls) are made.	
Weights	
Dialer unit	300g
Fully packaged	500g

Conformance

The IRIS range of alarm dialers comply with the following European Directives:

- 1999/5/EC (Radio & Telecoms Terminal Equipment Directive).
- 72/23/EEC (Low Voltage Directive).
- 89/336/EEC (Electromagnetic Compatibility Directive as amended by 92/31/EEC).

Conformance to EN50131 and EN50136

The IRIS dialers are compatible with the requirements of European standards prEN50131-1 (Alarm Systems – Intrusion and hold-up systems Part 1: System Requirements) (dated Feb 2004) and EN50136-1-1 (Alarm Systems – Alarm transmission systems and equipment) (January 1998 with Amendment 1 August 2001) as follows:

- The IRIS dialers conform to Environmental Class II.
- The IRIS dialers are compliant to ATS 6 compatible with Security Grade 4.

Safety

Care should be taken when interconnecting telecommunications equipment that only like interfaces are interconnected to avoid safety hazards.

SELV: SELV (Safety Extra-Low Voltage) is defined as a secondary circuit which is so designed and protected that under normal and single fault conditions the voltage between any two accessible parts does not exceed a safe value (42.4V peak or 60V dc maximum).

The interfaces on the IRIS dialer have the following safety classifications:

- Dialer Interface: SELV suitable for connection to the TNV interface of a single line telecommunications equipment such as telephones, faxes, etc.
- Data Interface: SELV suitable for connection to the SELV interface on a data terminal such as a PC COM port.
- Power Interface: SELV for connection to a DC supply.
- Inputs and Outputs: SELV for connection to alarm output and input pins.